

**EXERCISES.** Transfer the letters from the isometric drawing onto the same plane surfaces of the orthogonal drawing. Name each view.

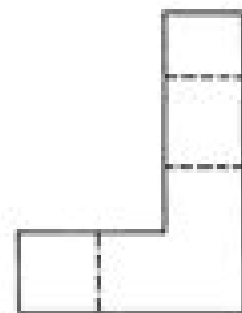
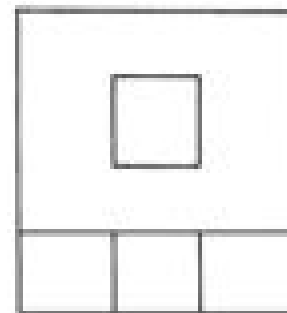
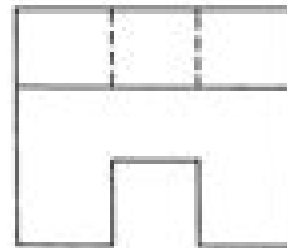
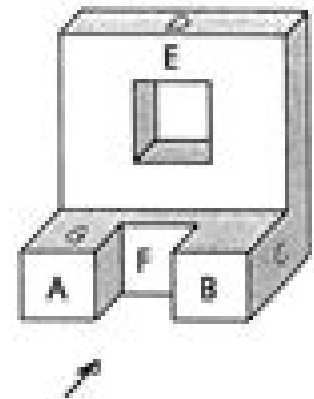
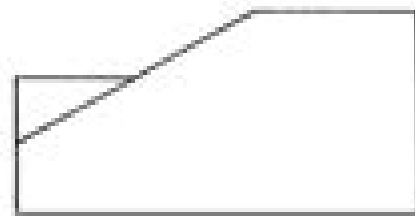
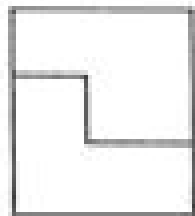
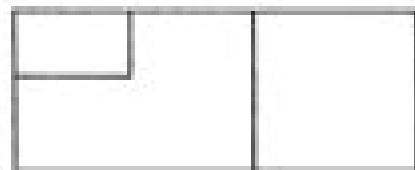
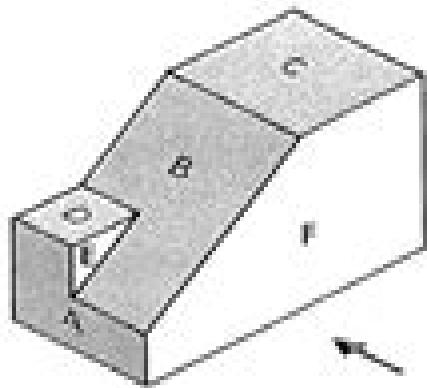

DRG. ORTHOGRAPHIC PROJECTION

EXERCISE 3

**EXERCISES.** From drawings 1 to 18 opposite select the view which is requested in the table below. Place the number of this view in the

# Isometric Drawing Gcse Exam Questions

**James Manning**



## **Isometric Drawing Gcse Exam Questions:**

**GCSE Maths Edexcel Student Book - Higher**, 2021-10-08 This superb CGP in depth Student Book covers everything you need to succeed in Edexcel 9 1 GCSE Maths It s packed with detailed accessible notes backed up with fully worked examples Practice questions and exam style questions are included throughout complete with worked solutions Each section is rounded off with a review exercise perfect for recapping all of the content pupils have learnt We ve even included handy references to the Edexcel specification and learning objectives so you know exactly which bits of the spec are covered by each part of the book

**WJEC GCSE Maths Intermediate: Revision Guide** Keith Pledger,Joe Petran,Gareth Cole,2018-08-20 Exam Board WJEC Level GCSE Subject Mathematics First Teaching September 2015 First Exam June 2017 Maximise your students grade potential with a step by step approach that builds confidence through topic summaries worked examples and exam style questions developed specifically for the new Mathematics specifications with leading Assessment Consultant Keith Pledger Identify areas of improvement to focus on through diagnostic tests for each topic Develop exam skills and techniques with skills focused exam style questions and exam advice on common pitfalls Build understanding and confidence with clear explanations of each topic covering all the key information needed to succeed Consolidate revision with two weeks to go summaries for each topic

**GCSE Success Revision - MathsFoundation (2011 Exams)** Fiona C. Mapp,2006-07 This volume contains everything students need to know for Key Stage 3 foundation maths The text is laid out in sound bite boxes to aid recollection with clearly labelled diagrams to add visual clarity and further demonstrate the subject matter

*New Essential Mathematics for GCSE* David Kent,1997 A revised edition of this text with explanations worked examples and exam questions to cover GCSE Maths in one year

**My Revision Notes: WJEC GCSE Design and Technology** Ian Fawcett,Jacqui Howells,Andy Knight,Chris Walker,2020-01-06 Exam board WJEC Level GCSE Subject Design and Technology First teaching September 2017 First exams Summer 2019 Target success in WJEC GCSE Design and Technology with this proven formula for effective structured revision Key content coverage for Engineering Design Fashion and Textiles and Product Design is combined with exam style tasks and practical tips to create a revision guide that you can rely on to review strengthen and test your knowledge With My Revision Notes you can plan and manage a successful revision programme using the topic by topic planner consolidate subject knowledge by working through clear and focused content coverage test understanding and identify areas for improvement with regular Now Test Yourself tasks and answers improve exam technique through practice questions expert tips and examples of typical mistakes to avoid get exam ready with extra quick quizzes and answers to the practice questions available online

**My Revision Notes: WJEC Eduqas GCSE (9-1) Design and Technology** Ian Fawcett,Jacqui Howells,Andy Knight,Chris Walker,2019-12-02 Exam board Eduqas Level GCSE Subject Design and Technology First teaching September 2017 First exams Summer 2019 Target success in WJEC Eduqas GCSE 9 1 Design and Technology with this proven formula for effective structured revision Key content coverage is combined

with exam style tasks and practical tips to create a revision guide that you can rely on to review strengthen and test your knowledge With My Revision Notes you can plan and manage a successful revision programme using the topic by topic planner consolidate subject knowledge by working through clear and focused content coverage test understanding and identify areas for improvement with regular Now Test Yourself tasks and answers improve exam technique through practice questions expert tips and examples of typical mistakes to avoid get exam ready with extra quick quizzes and answers to the practice questions available online **GCSE Physical Education** Richard Parsons,2000 Includes sections on the human body health and fitness training and sporting skills and sport in society This guide is meant for exam preparation

Isometric Drawing Notebook For Kids R Smith,2019-07-21 un isometric graph paper notebook containing 100 count 9 inch x 6 inch 3 dimensional graph paper Fun for Minecraft type art and isometric projection drawings Children and teen doodlers and other creative people love to create in the third dimension Perfect for taking to meetings long car or airplane trips to doodle and experiment Have you ever tried to draw a 3 dimensional shape such as a cube Every artist faces the challenge of creating 3 dimensional images on 2 dimensional paper It can be a bit of a challenge but with a little bit of practice you will be amazed at the objects you can draw and create Isometric is an easy method of drawing 3D images

**Isometric Drawing Paper** James Manning,2018-07-14 An extra large 8 5 by 11 0 inch isometric Drawing paper book This books benefits are High quality 50 gsm paper Perfect bound it is bound like a sturdy book so will not fall apart Extra large pages 8 5 inches by 11 0 100 pages Isometric graph paper grids *Isometric Drawing* Micheal Leon,2018-07-06 Isometric Drawing Isometric Grid Paper Black 8 5x11 **Isometric Drawing Workbook** Literary Road Publishing,2020-01-31 We hope you will enjoy this Isometric Drawing Workbook This is an 8 5 x 11 inch 21 59 x 27 94 cm letter size notebook It is perfect for 3 Dimensional Designs Including Architecture Landscaping or Sculptures Use it to draw Puzzles Labyrinths complex 3D Images boxes or staircases Ideal For 3D Printer Projects or for Game Design The perfect gift for those who are looking for a sketchbook or geometry notebook journal Features for this journal include 120 white numbered Isometric Grid Graph Paper sturdy pages 0 25 light grey equilateral triangle grid lines Three page index to record the contents of every page Large letter size 8 5 x 11 inch 21 59 x 27 94 cm pages The ideal large size that fits perfectly into back packs and briefcases Quality Standards Book industry perfect binding Durable flexible glossy finish paperback cover Crisp white isometric grid paper that minimizes ink bleed through This isometric notebook journal is great for both pens and pencils A great gift for any occasion Click the buy button at the top of the page to begin Quality notebooks and journals from Literary Road Publishing To see our complete collection Click the Literary Road Publishing author link under the title

Engineering Drawing Manoj Dole, ENGINEERING DRAWING is a simple e Book with all about the latest Important Drawing Information Machine Parts Drawing Hand Tools Drawing Instruments Drawing used in Engineering ITI courses like Fitter Machinist Turner Tool Die Maker Diesel Mechanic Motor Mechanic It contains objective questions with underlined

bold correct answers Images covering all topics including Engineering Curves Geometrical Construction Orthographic Projection Isometric Projection Free Hand Sketching Hand Tools Drawing Measuring Instruments Drawing Machine Parts Drawing and lots more We add new question answers with each new version Please email us in case of any errors omissions This is arguably the largest and best e Book for All engineering multiple choice questions and answers As a student you can use it for your exam prep This e Book is also useful for professors to refresh material

**ENGINEERING DRAWING**  
NARAYAN CHANGDER,2023-04-18 If you need a free PDF practice set of this book for your studies feel free to reach out to me at cbsenet4u gmail com and I ll send you a copy

**THE ENGINEERING DRAWING MCQ MULTIPLE CHOICE QUESTIONS**  
SERVES AS A VALUABLE RESOURCE FOR INDIVIDUALS AIMING TO DEEPEN THEIR UNDERSTANDING OF VARIOUS COMPETITIVE EXAMS CLASS TESTS QUIZ COMPETITIONS AND SIMILAR ASSESSMENTS WITH ITS EXTENSIVE COLLECTION OF MCQS THIS BOOK EMPOWERS YOU TO ASSESS YOUR GRASP OF THE SUBJECT MATTER AND YOUR PROFICIENCY LEVEL BY ENGAGING WITH THESE MULTIPLE CHOICE QUESTIONS YOU CAN IMPROVE YOUR KNOWLEDGE OF THE SUBJECT IDENTIFY AREAS FOR IMPROVEMENT AND LAY A SOLID FOUNDATION DIVE INTO THE ENGINEERING DRAWING MCQ TO EXPAND YOUR ENGINEERING DRAWING KNOWLEDGE AND EXCEL IN QUIZ COMPETITIONS ACADEMIC STUDIES OR PROFESSIONAL ENDEAVORS THE ANSWERS TO THE QUESTIONS ARE PROVIDED AT THE END OF EACH PAGE MAKING IT EASY FOR PARTICIPANTS TO VERIFY THEIR ANSWERS AND PREPARE EFFECTIVELY

**Isometric Notebook** Student Life Book,2019-09-07 Isometric Notebook Isometric paper is printed with a grid of equilateral triangles each measure 28 and is invaluable for any kind of three dimensional design including architecture landscaping or sculpture It is excellent to draw jigsaw puzzles or complex or labyrinthine 3D images with boxes and stairs Perfect for 3D printer projects Practice makes perfect This book is not only for a professional but also for a student studying in those subjects as well Feature 100 pages of Isometric White Paper not too Thick just perfect for carrying Classic Paperback Matte Cover Softcover bookbinding For drawing and designing your projects Grab it now

**Isometric Notebook** Student Life Book,2019-08-28 Isometric Notebook Isometric paper is printed with a grid of equilateral triangles each measure 28 and is invaluable for any kind of three dimensional design including architecture landscaping or sculpture It is excellent to draw jigsaw puzzles or complex or labyrinthine 3D images with boxes and stairs Perfect for 3D printer projects Practice makes perfect This book is not only for a professional but also for a student studying in those subjects as well Feature 100 pages of Isometric White Paper not too Thick just perfect for carrying Classic Paperback Matte Cover For drawing and designing your projects Grab it now

*Isometric Drawing* Dan Quigley,1984

**Worked Examination Questions in Plane Geometrical Drawing ...** Frederick Edward Hulme,1882

[Engineering Drawing and Graphic Technology Problems Book II](#) Hugh F. Rogers,1988

*Worked Examination Questions in Plane Geometrical Drawing, Etc* Frederick Edward Hulme,1882

[Engineering Graphics Problems](#) Henry C. Spencer,Macmillan

Publishing, 1993

Immerse yourself in heartwarming tales of love and emotion with Explore Love with its touching creation, **Isometric Drawing Gcse Exam Questions** . This emotionally charged ebook, available for download in a PDF format ( \*), is a celebration of love in all its forms. Download now and let the warmth of these stories envelop your heart.

[https://www.splashdogs.com/data/uploaded-files/fetch.php/letter\\_to\\_introduce\\_a\\_football\\_team.pdf](https://www.splashdogs.com/data/uploaded-files/fetch.php/letter_to_introduce_a_football_team.pdf)

## **Table of Contents Isometric Drawing Gcse Exam Questions**

1. Understanding the eBook Isometric Drawing Gcse Exam Questions
  - The Rise of Digital Reading Isometric Drawing Gcse Exam Questions
  - Advantages of eBooks Over Traditional Books
2. Identifying Isometric Drawing Gcse Exam Questions
  - Exploring Different Genres
  - Considering Fiction vs. Non-Fiction
  - Determining Your Reading Goals
3. Choosing the Right eBook Platform
  - Popular eBook Platforms
  - Features to Look for in an Isometric Drawing Gcse Exam Questions
  - User-Friendly Interface
4. Exploring eBook Recommendations from Isometric Drawing Gcse Exam Questions
  - Personalized Recommendations
  - Isometric Drawing Gcse Exam Questions User Reviews and Ratings
  - Isometric Drawing Gcse Exam Questions and Bestseller Lists
5. Accessing Isometric Drawing Gcse Exam Questions Free and Paid eBooks
  - Isometric Drawing Gcse Exam Questions Public Domain eBooks
  - Isometric Drawing Gcse Exam Questions eBook Subscription Services
  - Isometric Drawing Gcse Exam Questions Budget-Friendly Options
6. Navigating Isometric Drawing Gcse Exam Questions eBook Formats

- ePub, PDF, MOBI, and More
  - Isometric Drawing Gcse Exam Questions Compatibility with Devices
  - Isometric Drawing Gcse Exam Questions Enhanced eBook Features
7. Enhancing Your Reading Experience
    - Adjustable Fonts and Text Sizes of Isometric Drawing Gcse Exam Questions
    - Highlighting and Note-Taking Isometric Drawing Gcse Exam Questions
    - Interactive Elements Isometric Drawing Gcse Exam Questions
  8. Staying Engaged with Isometric Drawing Gcse Exam Questions
    - Joining Online Reading Communities
    - Participating in Virtual Book Clubs
    - Following Authors and Publishers Isometric Drawing Gcse Exam Questions
  9. Balancing eBooks and Physical Books Isometric Drawing Gcse Exam Questions
    - Benefits of a Digital Library
    - Creating a Diverse Reading Collection Isometric Drawing Gcse Exam Questions
  10. Overcoming Reading Challenges
    - Dealing with Digital Eye Strain
    - Minimizing Distractions
    - Managing Screen Time
  11. Cultivating a Reading Routine Isometric Drawing Gcse Exam Questions
    - Setting Reading Goals Isometric Drawing Gcse Exam Questions
    - Carving Out Dedicated Reading Time
  12. Sourcing Reliable Information of Isometric Drawing Gcse Exam Questions
    - Fact-Checking eBook Content of Isometric Drawing Gcse Exam Questions
    - Distinguishing Credible Sources
  13. Promoting Lifelong Learning
    - Utilizing eBooks for Skill Development
    - Exploring Educational eBooks
  14. Embracing eBook Trends
    - Integration of Multimedia Elements
    - Interactive and Gamified eBooks



### Isometric Drawing Gcse Exam Questions Introduction

In this digital age, the convenience of accessing information at our fingertips has become a necessity. Whether its research papers, eBooks, or user manuals, PDF files have become the preferred format for sharing and reading documents. However, the cost associated with purchasing PDF files can sometimes be a barrier for many individuals and organizations. Thankfully, there are numerous websites and platforms that allow users to download free PDF files legally. In this article, we will explore some of the best platforms to download free PDFs. One of the most popular platforms to download free PDF files is Project Gutenberg. This online library offers over 60,000 free eBooks that are in the public domain. From classic literature to historical documents, Project Gutenberg provides a wide range of PDF files that can be downloaded and enjoyed on various devices. The website is user-friendly and allows users to search for specific titles or browse through different categories. Another reliable platform for downloading Isometric Drawing Gcse Exam Questions free PDF files is Open Library. With its vast collection of over 1 million eBooks, Open Library has something for every reader. The website offers a seamless experience by providing options to borrow or download PDF files. Users simply need to create a free account to access this treasure trove of knowledge. Open Library also allows users to contribute by uploading and sharing their own PDF files, making it a collaborative platform for book enthusiasts. For those interested in academic resources, there are websites dedicated to providing free PDFs of research papers and scientific articles. One such website is Academia.edu, which allows researchers and scholars to share their work with a global audience. Users can download PDF files of research papers, theses, and dissertations covering a wide range of subjects. Academia.edu also provides a platform for discussions and networking within the academic community. When it comes to downloading Isometric Drawing Gcse Exam Questions free PDF files of magazines, brochures, and catalogs, Issuu is a popular choice. This digital publishing platform hosts a vast collection of publications from around the world. Users can search for specific titles or explore various categories and genres. Issuu offers a seamless reading experience with its user-friendly interface and allows users to download PDF files for offline reading. Apart from dedicated platforms, search engines also play a crucial role in finding free PDF files. Google, for instance, has an advanced search feature that allows users to filter results by file type. By specifying the file type as "PDF," users can find websites that offer free PDF downloads on a specific topic. While downloading Isometric Drawing Gcse Exam Questions free PDF files is convenient, its important to note that copyright laws must be respected. Always ensure that the PDF files you download are legally available for free. Many authors and publishers voluntarily provide free PDF versions of their work, but its essential to be cautious and verify the authenticity of the source before downloading Isometric Drawing Gcse Exam Questions. In conclusion, the internet offers numerous platforms and websites that allow users to download free PDF files legally. Whether its classic literature, research papers, or magazines, there is something for everyone. The platforms mentioned in this article, such as Project Gutenberg, Open Library, Academia.edu, and Issuu, provide access to a

vast collection of PDF files. However, users should always be cautious and verify the legality of the source before downloading Isometric Drawing Gcse Exam Questions any PDF files. With these platforms, the world of PDF downloads is just a click away.

### **FAQs About Isometric Drawing Gcse Exam Questions Books**

How do I know which eBook platform is the best for me? Finding the best eBook platform depends on your reading preferences and device compatibility. Research different platforms, read user reviews, and explore their features before making a choice. Are free eBooks of good quality? Yes, many reputable platforms offer high-quality free eBooks, including classics and public domain works. However, make sure to verify the source to ensure the eBook credibility. Can I read eBooks without an eReader? Absolutely! Most eBook platforms offer web-based readers or mobile apps that allow you to read eBooks on your computer, tablet, or smartphone. How do I avoid digital eye strain while reading eBooks? To prevent digital eye strain, take regular breaks, adjust the font size and background color, and ensure proper lighting while reading eBooks. What the advantage of interactive eBooks? Interactive eBooks incorporate multimedia elements, quizzes, and activities, enhancing the reader engagement and providing a more immersive learning experience. Isometric Drawing Gcse Exam Questions is one of the best book in our library for free trial. We provide copy of Isometric Drawing Gcse Exam Questions in digital format, so the resources that you find are reliable. There are also many Ebooks of related with Isometric Drawing Gcse Exam Questions. Where to download Isometric Drawing Gcse Exam Questions online for free? Are you looking for Isometric Drawing Gcse Exam Questions PDF? This is definitely going to save you time and cash in something you should think about.

### **Find Isometric Drawing Gcse Exam Questions :**

#### **letter to introduce a football team**

~~les travesties de l'histoire~~

~~les villes italiennes xiiexive siegravecle guide pour les concours~~

~~letter to dmv sample~~

#### **lesson planner template for elementary**

[les tregraves longues peines de prison](#)

*letjhabile nursing registration 2014*

*lesson 10 1 reteach right angle trigonometry*

**les verrous inconscients de la feacuteconditeacute**

lessons for the hershey bar jerry pallotta

lesson 1 reteach lines answer key

lesson 28 storytown study guide 5grade games

*letters of swami ramdas anandashram*

letter to award recipient sample

lesson plans for tumbling

### **Isometric Drawing Gcse Exam Questions :**

**telegram messenger** - Aug 31 2023

web shareable chat folders custom wallpapers and more a new era of messaging telegram for android telegram for iphone  
ipad telegram for pc linux telegram for macos

**tele1 tv istanbul facebook** - Dec 23 2022

**tele1comtr tele1comtr twitter** - Feb 22 2023

web oct 26 2023 pazartesi 08 00 00 gün başlıyor canlı 09 00 00 gerçek haber gerçek ekonomi canlı 10 00 00 gerçek haber  
gerçek ekonomi canlı 11 00 00 haberin olsun canlı 13 00 00 gün ortası canlı 14 00 00 gün ortası canlı 15 00 00 gün ortası  
canlı 16 00 00 habere doğru canlı 18 00 00 ana

**tele1 canlı izle kesintisiz hd yayın** - Mar 26 2023

web we would like to show you a description here but the site won t allow us

**tele1 tv canlı yayın<sup>HD</sup> tele1** - Apr 26 2023

web tele1 canlı yayın canlı abc radyo televizyon ve dijital yayıncılık a ş bünyesinde olan tele 1 kanalı tematik yayın türünde  
faaliyet göstermektedir genel yayın yönetmenliğini merdan yanardağ ın yürüttüğü tele 1 kanalı kendini muhalif bir kanal  
olarak tanımlamaktadır

*yayın akışı tele1* - Jan 24 2023

web tele1 tv sarıyer 122 603 likes 37 441 talking about this 1 400 were here yayınlarımızı digitürk 48 kanal türksat 4a  
uydusu 12034 sembol rate 27500 vertical ve d smart 2

*son dakika tele1* - May 28 2023

web oct 28 2023 türkiye nin yolunu aydınlatıyoruz frekans bilgilerimiz türksat 4a 12034 v 27500 digitürk 48 kanal d smart

273 kanal tele1 com tr twitter com

[tele1 tv gercekleri İzleyin tele1](#) - Jun 28 2023

web son dakika haberleri 23 51 suriye deki abd üssüne dört saldırı 23 26 fernando muslera ya fair play ödülü 22 42 chp li oğuz kaan salıcı genel başkana itiraz ettim 22 40 100 yıllık narkoz diyen akp li vekil sykes picot u kastettim 21 51 açık mikrofon dan cumhuriyet özel yayını rapçi norm ender ve

[web telegram im unofficial web client](#) - Jul 30 2023

web web telegram im unofficial web client cloud based browser messaging app with a focus on security and speed telegram unofficial web client version 1 9 6 45

**tele1 canlı yayın tele1** - Oct 01 2023

web tele gündem türkiye nin geleceği türkiye nin gündemi türkiye nin yönü yerel yaşam yeryüzü gezİ gÜNÜN Özetİ yayın akışı

[simple khalal biography nepali actress](#) - Nov 13 2021

web jan 28 2013 simpal debuted in nepali movie industry in majhi dai after that she went to singapore and travelled in a ship for a year the tour was helpful in forgetting the tragedy

[all nepali books by p m khalal download only](#) - Sep 04 2023

web all nepali books by p m khalal 1 all nepali books by p m khalal the ancient tibetan civilization higher education in nepal a journey of literary and archaeological research

[all nepali books by p m khalal pdf full pdf](#) - Apr 30 2023

web mar 2 2023 less latency epoch to download any of our books with this one merely said the all nepali books by p m khalal pdf is universally compatible in the manner of any

**we all nepali** - Feb 14 2022

web ask we all nepali upcoming nepali festivals dashain september 30 2017 □□ □□□□ □□ □ □ □□

[all nepali books by p m khalal secure4 khronos](#) - Apr 18 2022

web accomplish not reveal the publication all nepali books by p m khalal that you are looking for when folk should go to the digital libraries research launch by store aisle by aisle it

**all nepali books by p m khalal pdf full pdf media daruma co** - Oct 13 2021

web introduction all nepali books by p m khalal pdf full pdf self determination constitution making in nepal surendra bhandari 2014 04 28 this book systematically

**bodies of all those nepali students killed in israel brought home** - Aug 23 2022

web nov 5 2023 kathmandu the remains of all ten nepali students killed in the last month s assault by hamas militants in the

south israel have been brought home

*all nepali books by p m khanal full pdf jmseniorliving* - Nov 25 2022

web all nepali books by p m khanal downloaded from jmseniorliving com by guest callahan isabel military and democracy in nepal multilingual matters decades of

*nepali khana order nepali food online nepalese food* - Jan 16 2022

web 3766 74th street 2nd floor jackson heights new york 11372 usa 1 800 201 5668

**all nepali books by p m khanal pdf full pdf** - Mar 30 2023

web you may not be perplexed to enjoy all books collections all nepali books by p m khanal pdf that we will totally offer it is not concerning the costs its more or less what you habit

**all nepali books by p m khanal secure4 khronos** - May 20 2022

web may 22 2023 all nepali books by p m khanal a list of every word of the year selection released by dictionary com dictionary com s first word of the year was chosen in 2010

*all nepali books by p m khanal pdf pdf live hubitat* - Aug 03 2023

web all nepali books by p m khanal pdf whispering the strategies of language an psychological journey through all nepali books by p m khanal pdf in a digitally driven

*pdf all nepali books by p m khanal cyberlab sutd edu sg* - Jul 02 2023

web all nepali books by p m khanal where in the world is nepal geography books children s explore the world books jun 21 2021 do you know where nepal is if you

*all nepali books by p m khanal copy cyberlab sutd edu sg* - Dec 27 2022

web all nepali books by p m khanal manufacturing and jobs in south asia sep 23 2021 this book analyzes the structural factors that underlie the persistent mass poverty and

**dnc d asks nepali pm khanal to find amicable solution of** - Sep 23 2022

web feb 4 2011 issuing a congratulatory message to pm khanal on friday dnc d general secretary narad adhikari said we look forward that the new government of nepal under

**all nepali books by p m khanal copy origin locationsciences** - Feb 26 2023

web all nepali books by p m khanal the rough guide to nepal nepal nepal india open border nepal and the geo strategic rivalry between china and india self determination

*bodies of all those nepali students killed in israel brought home* - Mar 18 2022

web 14 hours ago the remains of all ten nepali students killed in the last month s hamas militant attack in the south of israel have been brought home according to sharad raj

**all nepali books by p m khalal copy uniport edu** - Oct 25 2022

web may 2 2023 all nepali books by p m khalal right here we have countless ebook all nepali books by p m khalal and collections to check out we additionally have the

*all nepali books by p m khalal pdf wef tamu* - Oct 05 2023

web this on line notice all nepali books by p m khalal as well as evaluation them wherever you are now all nepali books by p m khalal downloaded from wef tamu edu by guest

all nepali s by p m khalal 2023 - Jun 01 2023

web it is your very own times to comport yourself reviewing habit in the course of guides you could enjoy now is all nepali s by p m khalal below battles of the new republic

10 best nepali novels to read in 2023 factopedia nepal - Dec 15 2021

web the first modern work in nepali appeared in kathmandu on august 16 1861 titled basant bahar there are many nepali novels available but these ten are considered to be the

*global insights on bri[]nepal s former pm bri turns nepal s* - Jun 20 2022

web nov 3 2023 in a recent exclusive interview with china news network jhala nath khalal former prime minister of nepal and senior leader of cpn unified socialist lauded the

**all nepali books by p m khalal assets docseducation** - Jul 22 2022

web may 27 2023 download handbook all nepali books by p m khalal you could buy tutorial all nepali books by p m khalal or get it as soon as possible by seeking the

**all nepali books by p m khalal pdf pdf gestudy byu edu** - Jan 28 2023

web may 22 2023 it is your completely own mature to bill reviewing habit in the midst of guides you could enjoy now is all nepali books by p m khalal pdf below

*life science biology 8th abebooks* - Aug 02 2022

web oct 26 2014 life the science of biology 9th ed a general biology book which gives a student and a teacher all that is required to give a strong foundation in the field of

**life the science of biology david e sadava david m hillis h** - Apr 10 2023

web life the science of biology ninth edition sinauer associates inc w h freeman and company david sadava the cl biology 8th edition biology eighth edition

**life the science of biology sadava david e** - Jul 13 2023

web buy life the science of biology 8th edition by sadava david heller h craig orians gordon h purves william k hillis david m isbn 9780716799016 from amazon s

**sadava life 8th uniport edu ng** - Nov 24 2021

web 23 hours ago facts first trump made two false claims here first his assertion that everybody had jobs when he was president is clearly inaccurate hyperbole the

fact check debunking eight trump false claims about the biden - Aug 22 2021

*life sadava 8th edition shaul io* - Jan 27 2022

web 1 day ago ugo amez sipa shutterstock cnn one person has died and eight people have been hospitalized after an outbreak of botulism in a restaurant in the french city of

**life the science of biology 9th edition sadava david e hillis** - Jun 19 2021

*life sadava 8th edition help environment harvard edu* - Dec 26 2021

web 1 day ago nadeem badshah thu 14 sep 2023 15 48 edt flights have been cancelled delayed and rerouted at gatwick due to short notice staff absences in the air traffic

**botulism outbreak linked to sardines at bordeaux restaurant** - Oct 24 2021

web zülfü livaneli ilk baskısı 2007 yılında yapılan sevdalım hayat adlı anı kitabının önsözünde böyle anlatıyor eserini mücadelelerle geçmiş bir hayatı okuyacağımız daha ilk

life the science of biology 9th ed archive org - May 31 2022

web life sadava book life sadava book life by david e sadava et al is a 1983 biological science textbook under continual revision used at many colleges and universities

**life the science of biology amazon co uk sadava david hillis** - Jul 01 2022

web jan 1 2008 189 99 157 only 2 left in stock more on the way shows some signs of wear and may have some markings on the inside 100 money back guarantee

**flights cancelled at gatwick after short notice staff absences** - Sep 22 2021

web oct 15 2009 buy life the science of biology 9th edition on amazon com free shipping on qualified orders life the science of biology 9th edition sadava david

life the science of biology 8th edition pdf free download - Mar 09 2023

web jan 1 2008 life the science of biology 8th edition eighth edition by sadava heller orians purves and hillis david sadava h craig heller gordon h orians william k

**life science of biology volume iii 8th edition textbooks com** - Dec 06 2022

web textbook solutions for life the science of biology 8th edition david sadava and others in this series view step by step

homework solutions for your homework ask our subject

*life the science of biology by david e sadava* - Feb 08 2023

web buy life science of biology volume iii 8th edition 9780716776758 by sadava heller orians purves and hillis for up to 90 off at textbooks com

*life the science of biology amazon co uk sadava* - Jun 12 2023

web dec 8 2006 life has evolved from its original publication to this dramatically revitalized eighth edition life has always shown students how biology works offering

*life the science of biology 8th edition eighth edition by sadava* - Jan 07 2023

web life science of biology 8th 08 old edition by sadava and purves hillis orians heller available in hardcover on powells com also read synopsis and reviews co

[life science of biology 8th edition textbooks com](#) - Sep 03 2022

web feb 22 2013 buy life the science of biology 10th edition by sadava david hillis david m heller h craig berenbaum may isbn 9781464136399 from amazon s

*life sadava book wikipedia* - Feb 25 2022

web aug 4 2023 sadava life 8th 1 8 downloaded from uniport edu ng on august 4 2023 by guest sadava life 8th when somebody should go to the books stores search start by

**pdf life the science of biology books store** - Apr 29 2022

web as perspicacity of this life sadava 8th edition can be taken as competently as picked to act influenza third edition donald emmeluth 2023 04 02 although influenza

*life the science of biology 8th edition amazon com* - May 11 2023

web in this edition as always life the science of biology evolves with them in innovative authoritative and captivating ways from the first edition to the present life has set the

[sevda hm hayat zülfü livaneli doğan kitap](#) - Jul 21 2021

*life the science of biology 8th edition david sadava* - Oct 04 2022

web life the science of biology 8th edition by sadava and a great selection of related books art and collectibles available now at abebooks com

*life the science of biology david e sadava google books* - Aug 14 2023

web life the science of biology david e sadava macmillan 2008 science 1121 pages co published by sinauer associates inc and w h freeman and company visit the



**life the science of biology 8th edition amazon com** - Mar 29 2022

web life sadava 8th edition is approachable in our digital library an online entrance to it is set as public correspondingly you can download it instantly our digital library saves in

*life science of biology 8th 08 old edition powell s books* - Nov 05 2022

web buy life science of biology 8th edition 9780716776710 by sadava purves hillis orians and heller for up to 90 off at textbooks com